



Magna-Grip[®]

The Original Wide Grip
Range Fastener Proven in
Thousands of Applications.

Vibration resistant
Flush-breaking
Easy installation

3/16"-3/8"



Huck Magna-Grip®

Magna-Grip® fasteners. A unique, lock-groove design ensures a secure installation.

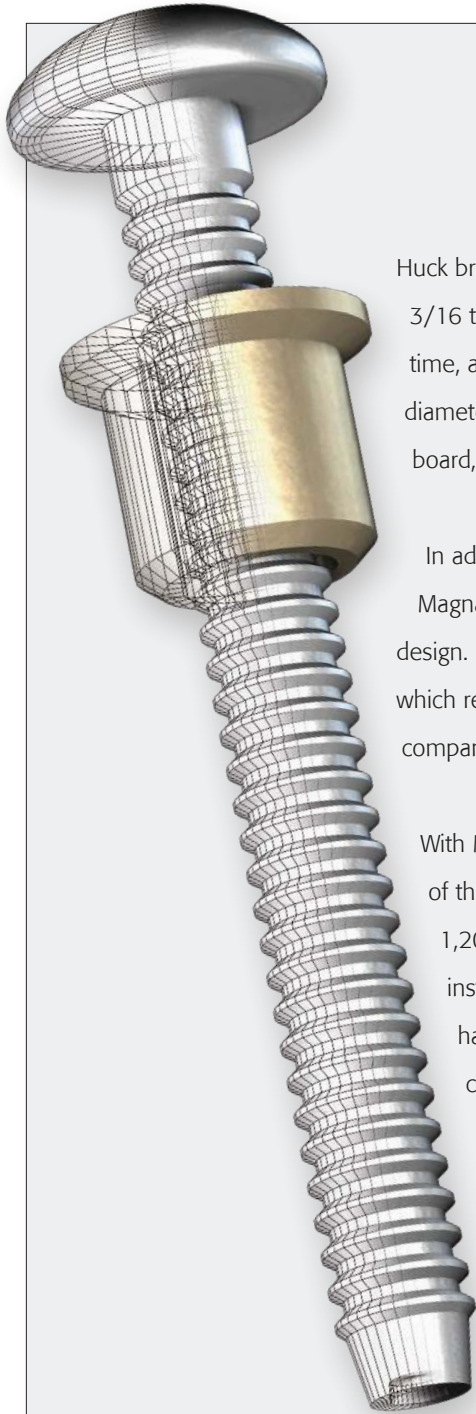

Huck brand Magna-Grip fasteners offer a generous selection of diameters – from 3/16 to 3/8 inch – for light to heavy-duty applications. They break flush, every time, and provide multi-thickness capability thanks to a wide grip range for each diameter. With Magna-Grip fasteners you achieve clean installations across-the-board, for a variety of assembly thicknesses, while stocking less inventory.

In addition to consistent clamp force, shear, and tensile strength, the Huck Magna-Grip ensures absolute vibration resistance with a unique locking-groove design. It simply can't come loose no matter how demanding the application – which reduces rework and warranty claims, providing long-term savings for your company and increased satisfaction for your customers.

With Magna-Grip fasteners, quality installations do not depend upon the skill of the worker or a correctly calibrated tool. They install in seconds (up to 1,200 per hour) and require no more than a glance to confirm a correct installation: If the core pin is flush with the collar, the Magna-Grip fastener has been properly installed. It's that simple. And the installation process can be mastered in minutes with minimal training.

Installation Sequence

Perfect installations do not depend upon worker skill or a precisely calibrated impact wrench — and can be achieved with just a few minutes training.

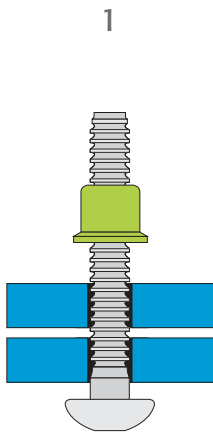

The fastener pin is inserted through a prepared hole. The precision collar is placed over the other end.

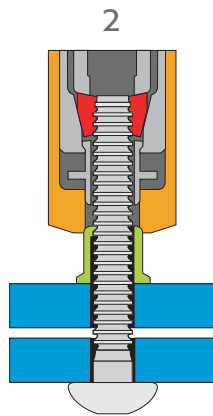

The Huck installation tool is applied and engages the pin. When the tool is activated, it pulls the pin in a straight line while pushing down on the collar.

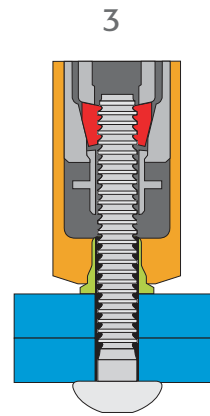

The tool moves forward over the collar, molding the collar material into the grooves of the pin. This process, called "swaging," causes a precise stretching of the pin and collar, developing the fastener's clamping force.

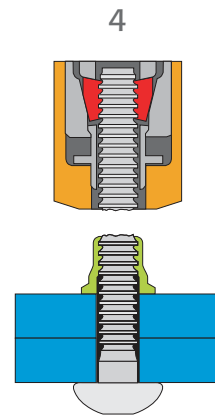

When swaging is complete the pintail is automatically tensioned off, flush with the end of the collar. The tool then pushes off from the collar. The result is a permanent, mechanically locked fastener.

Secure, fast installation.

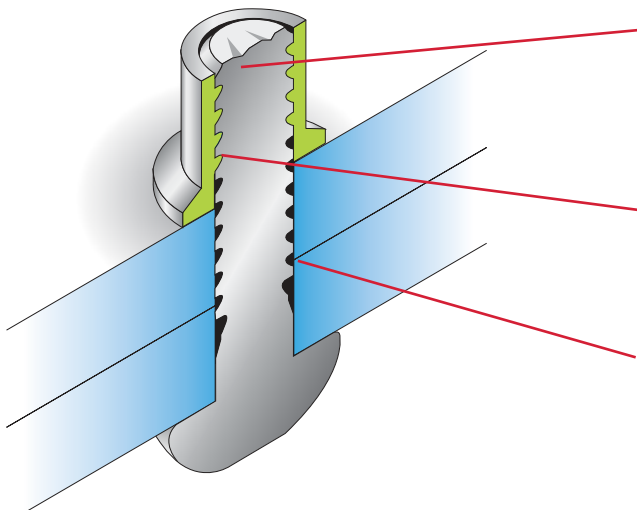

- Flush-breaking, lock-groove design provides a wide grip range to reduce inventory requirements. Easy, consistently accurate installations minimize operator errors and rework costs.
- Collar material swaged into the annular pin grooves forms a permanent, vibration-proof connection that promotes increased customer satisfaction and reduced warranty claims.
- Hole preparation isn't critical. Built-in system values yield high, consistent clamp loads, and gap removal.

Magna-Grip® benefits

- Unmatched installation speed
- Low overall installed cost
- Vibration resistance
- Flush-breaking pin
- Quiet non-torque tools
- No repetitive stress injuries
- Eliminates need for secondary operations
- No special training or skills required for operators

Data and dimensions

Head style options

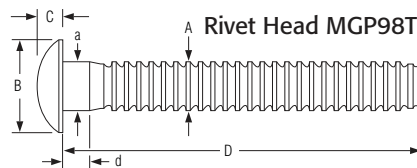
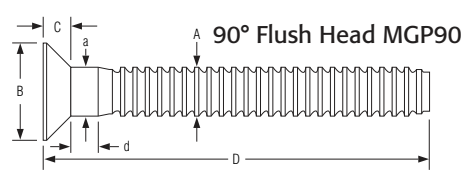
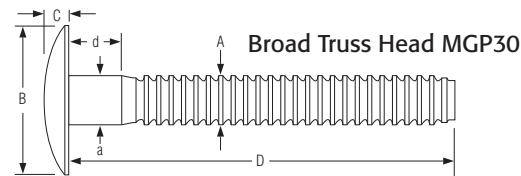
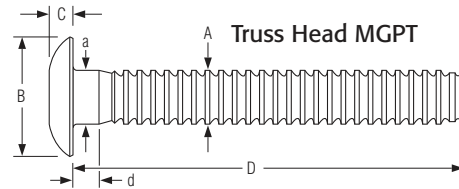
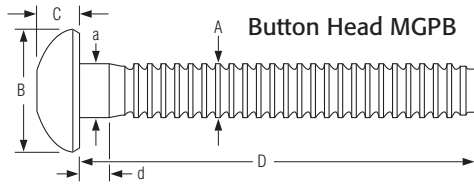

Button Head dimensions

Diameter	Grip Number	Grip Range	Hole Size max	A ref	B	C	D	a max	d ref
6 (3/16")	10	.062-0.625	.219	.186	.355-.395	.109-.129	1.778-1.828	.192	–
	20	.312-1.250	.219	.186	.355-.395	.109-.129	2.360-2.410	.259	.312
8 (1/4")	10	.062-0.625	.281	.248	.480-.520	.134-.154	1.945-2.085	.259	.125
	20	.312-1.250	.281	.248	.480-.520	.134-.154	2.580-2.680	.259	.312
10 (5/16")	12	.125-0.750	.359	.311	.595-.655	.176-.206	2.330-2.430	.322	*
	22	.625-1.375	.359	.311	.595-.655	.176-.206	2.830-2.930	.322	.550
12 (3/8")	14	.125-0.875	.422	.374	.720-.780	.220-.250	2.865-2.965	.385	.188
	26	.750-1.625	.422	.374	.720-.780	.220-.250	3.490-3.590	.385	.810

* Steel	–
Aluminum	.100

Truss Head dimensions

Diameter	Grip Number	Grip Range	Hole Size max	A ref	B	C	D	a max	d ref
8 (1/4")	10	.062-0.625	.281	.248	.542-.582	.100-.120	1.955-2.055	.259	.125
	20	.312-1.250	.281	.248	.542-.582	.100-.120	2.550-2.650	.259	.312
10 (5/16")	12	.125-0.750	.359	.311	.698-.802	.119-.149	2.330-2.430	.322	**
	22	.625-1.375	.359	.311	.698-.802	.119-.149	2.830-2.930	.322	.550
12 (3/8")	14	.125-0.875	.422	.374	.720-.905	***	2.865-2.965	.385	.188
	26	.750-1.625	.422	.374	.720-.905	***	3.490-3.590	.385	.810

** Steel	–
Aluminum	.150-.180

*** Steel	.145-.175
Aluminum	.180-.210

Broad Truss Head dimensions

Diameter	Grip Number	Grip Range	Hole Size max	A ref	B	C	D	a max	d ref
8 (1/4")	10	.062-0.625	.281	.248	*	.135-.165	1.955-2.055	.259	.125
	24	.062-1.500	.281	.248	*	.135-.165	2.800-2.900	.259	.562
12 (3/8")	14	.062-1.500	.422	.374	1.179-1.259	.185-.215	3.365-3.465	.385	.680
	26	1.125-2.000	.422	.374	1.179-1.259	.185-.215	3.865-3.965	.385	1.180

* Steel	0.898-0.978
Aluminum	1.023-1.103

90° Flush Head dimensions

Diameter	Grip Number	Grip Range	Hole Size max	A ref	B	C	D	a max	d ref
6 (3/16")	10	.062-0.625	.219	.186	.321-.361	.090-.105	1.778-1.828	.196	.157
	20	.312-1.250	.219	.186	.321-.361	.075-.090	2.360-2.410	.196	.408
8 (1/4")	10	.062-0.625	.281	.248	.425-.475	.115-.130	1.955-2.055	.259	.210
	20	.312-1.250	.281	.248	.425-.475	.100-.115	2.550-2.650	.259	.422
10 (5/16")	12	.125-0.750	.359	.311	.542-.594	.149-.162	2.330-2.430	.322	.227
	22	.625-1.375	.359	.311	.542-.594	.129-.142	2.830-2.930	.322	.727
12 (3/8")	14	.250-0.875	.422	.374	.652-.712	.171-.201	2.865-2.965	.385	.188
	26	.750-1.625	.422	.374	.652-.712	.146-.176	3.490-3.590	.385	.810

Rivet Head dimensions

Diameter	Grip Number	Grip Range	Hole Size max	A ref	B	C	D	a max	d ref
6 (3/16")	10	.062-0.625	.219	.186	.448-.488	.088-.108	1.778-1.828	.196	-
	20	.312-1.250	.219	.186	.448-.488	.088-.108	2.360-2.410	.196	.312

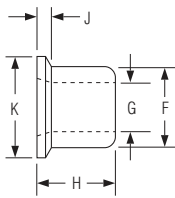

Standard Flange MGC

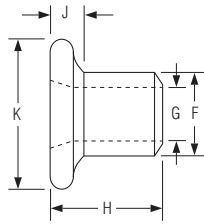

Medium Flange MGCS

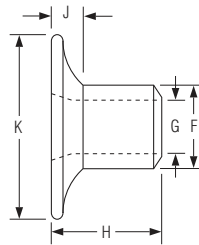

Wide Flange MGCW

Collar Dimensions

Collar	Diameter	F	G	H	J ref	K
MCG	3/16"	.305-.315	*	.267 - .283	.050	.360 - .390
	1/4"	.395-.405	.250 - .260	.367 - .383	.062	.485 - .515
	5/16"	.500-.510	.312 - .320	.428 - .448	.075	.605 - .645
	3/8"	.602-.612	.375 - .385	.495 - .515	.093	.730 - .770
MCGS	3/16"	.305-.315	*	.297 - .303	.100	.490 - .540
MCCW	3/16"	.305-.315	*	.290 - .320	.100	.635 - .760
	1/4"	.395-.405	.250-.260	.427 - .467	.130	.850 -1.010

* Steel	.187-.197
Aluminum	.194-.204

Installed Values in Nominal Grip (lbs.)

Diameter		Aluminum		Steel		Diameter		Aluminum		Steel	
		Minimum	Typical	Minimum	Typical			Minimum	Typical	Minimum	Typical
3/16"	Shear	750	1000	1725	2000	5/16"	Shear	2200	2700	3000	3900
	Tensile	900	1300	1650	2700		Tensile	2500	4100	4400	6200
	Clamp	550	800	1025	1500		Clamp	1600	2200	2300	2900
1/4"	Shear	1200	1600	2200	2700	3/8"	Shear	3000	3900	4200	6000
	Tensile	1620	2500	2950	4000		Tensile	4000	5500	6000	9000
	Clamp	950	1400	1350	2000		Clamp	2400	3200	3200	4000

Huck Magna-Grip® Installation Tooling

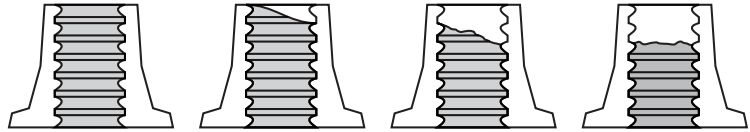
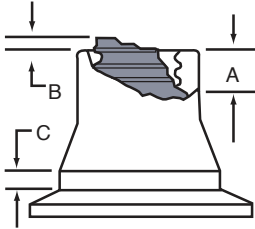

Acceptable Features- Substantially flush with end of collar up to a maximum of two lock witness marks within collar.

Inspection data

Diameter	A max	B max	C max
6 (3/16")	.062	.031	.050
8 (1/4")	.125	.093	.100
10 (5/16")	.187	.140	.100
12 (3/8")	.250	.171	.100

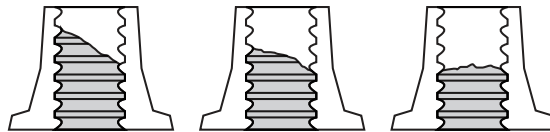

Unacceptable Features- Three witness marks within collar.

Ordering Information

Follow the tables below to construct part numbers for ordering Magna-Grip pins and collars. Refer to the Grip Data chart for grip numbers.

Pins

MGP (HEAD STYLE) - (MATERIAL) (DIAMETER) - (GRIP NUMBER) (FINISH)

Example: MGPB-R8-10G is a Magna-Grip fastener, Button Head, Steel, 1/4" Diameter, Grip 10 with a Zinc Finish

Head Style	Prefix
Button Head	B
Truss Head	T
Broad Truss Head	30
Rivet Head	98T
90° Flush Head	90

Material	Code
Steel	R
Aluminum	E

Diameter	Code
3/16"	6
1/4"	8
5/16"	10
3/8"	12

Grip Number
Please refer to the dimensional data chart.

Finish	Code
Zinc	G
Zinc Plating with Zinc Phosphate	GP

Collars

(FLANGE STYLE) - (MATERIAL) (DIAMETER) (FINISH) (OPTIONS)

Example: MGCW-R8U is a wide Flange Magna-Grip Collar, Steel, 1/4" Diameter, with a Zinc Finish

Flange Style	Prefix
Standard	MGC
Medium	MGCS
Wide	MGCW

Material	Code
Steel	R
Aluminum	F

Diameter	Code
3/16"	6
1/4"	8
5/16"	10
3/8"	12

Finish	Code
Zinc	U

Options	Code
Tab Lock	L

Huck Magna-Grip® Installation Tooling

Installation Tools

Pneudraulic Tools						Hydraulic Tools ²				
Tool Model	Size	2024	2025/ 2025S	255	256	2480/ A2480	2580/ A2580	2600	2620	2620PT
Nose Assembly	3/16"	99-3201	99-3201	99-3206	99-3206	99-3201	99-3206			
	1/4"	99-3204 ¹	99-3204	99-3207	99-3207	99-3204	99-3207			
	5/16"			99-1439	99-1439		99-1439	99-3217		
	3/8"			99-1440 ¹	99-1440		99-1440	99-3220	99-1492	H99-1492

¹Aluminum Only.

²Requires a PowerRig to operate.

Following are rigs that may be used:
918, 940, 968 and 913H (gas powered).



Model 255



Model 256



Model 2025



Model 2024



Model 2620



Model 2580



Model 2480

Tooling weight and dimensions

Model	Type	Weight	Length	Height	Width
2480	hydraulic	2.2 lbs	8.6"	6.5"	1.9"
2580	hydraulic	6.6 lbs	8.4"	6.5"	2.2"
2600	hydraulic	7.3 lbs	9.4"	6.9"	2.65"
2620/2620-PT	hydraulic	9.88 lbs	10.1"	7.0"	2.82"
255	pneudraulic	8.8 lbs	7.1"	14.9"	4.6"
256	pneudraulic	11.1 lbs	7.8"	14.9"	6.1"
2025	pneudraulic	5.75 lbs	8.4"	12.5"	4.4"
2024	pneudraulic	5.75 lbs	8.4"	12.5"	4.4"

Huck POWERIG Hydraulic Units

Model 918	Model 940	Model 913H (not shown)	Model 968 (not shown) ³
High-production applications	Portable; production and repair	Portable; production and repair	Portable; production and repair
Operates up to 2 tools; 2 gpm flow rate	70 in ³ /min flow rate	139 in ³ /min flow rate	50 in ³ /min flow rate
Electrically powered; 220, 440, or 550 volts, 3 phase	Electrically powered; 115 or 220 volts, single phase	Gasoline powered	Compressed Air minimum 50 CPM
Weighs 708 lbs, operational	Weighs 75 lbs	Weighs 175 lbs	Weighs 93 lbs, operational
44"L x 25"W x 30"H	12.5"L x 10.5"W x 18"H	24"L x 21"W x 27"H	10.5"L x 16.3"W x 15.7"H

³Requires air-triggered tools



Hydraulic POWERIG Model 918



Hydraulic POWERIG Model 940

Alcoa Fastening Systems & Rings



For more than 120 years, the name Alcoa has been recognized worldwide as a strong leader in product quality and customer support. These strengths are found in every product manufactured for Alcoa Fastening Systems & Rings, offering the greatest breadth and depth of fastening system solutions in the industry.

Alcoa Fastening Systems & Rings (AFSR) maintains company offices in the United States and in many other countries. AFSR fastener distributors are also located in many of the world's industrial centers, where they provide a ready source of AFSR fasteners, installation tools, tool parts, and application assistance.

Americas

Industrial Fasteners Division
Group Headquarters
8001 Imperial Drive
Waco, TX 76712, USA
P.O. Box 8117
Waco, TX 76714-8117, USA
Tel: 800 388 4825
Fax: 800 798 4825

Fasteners Division
1 Corporate Drive
Kingston, NY 12401, USA
Tel: 800 278 4825
Fax: 845 334 7333

Industrial Distribution Group
1925 North MacArthur Drive
Tracy, CA 95376, USA
Tel: 209 839 3000
Fax: 209 839 3022

Industrial Distribution Group
14300 Clay Terrace Blvd.
Suite 250
Carmel, IN 46032, USA
Tel: 800 826 2884
Fax: 800 573 2645

Industrial Fasteners Division
Avenida Parque Lira
79-402 Tacubaya
Mexico C P 11850
Tel: +52 55 5515 1776
Fax: +52 55 5277 7564

Industrial Fasteners Division
Av. Nações Unidas, 12.901
Torre Oeste, 3º andar
São Paulo – SP – Brasil
04578-000
Tel: 0800 015 9888
Fax: +55 11 5509 0200

International Locations

Industrial Fasteners Division
Unit no. 28, Chowringhee Court
55/1, Chowringhee Road
Kolkata – 700071
India
Tel: +91 33 4069 9170/80
Fax: +91 33 4069 9184

Industrial Fasteners Division
Alcoa Japan Ltd.
#1013 NBF Hibiya Bldg.
Uchisaiwai-cho, Chiyoda-ku
Tokyo 100-1011
Japan
Tel: +81 3 3539 6577
Fax: +81 3 3539 6585

Industrial Fasteners Division
1508 Centre Road
Clayton, Victoria, 3168
Australia
Tel: +61 3 8545 3333
Fax: +61 3 8545 3390

Fasteners Division
58 Yinsheng Road, Shengpu
Suzhou Industrial Park
Suzhou Jiangsu 215126
China
Tel: 0512 62823800-8888
Fax: 0512 62863810

Industrial Fasteners Division
Unit C, Stafford Park 7
Telford, Shropshire TF3, 3BQ
United Kingdom
Tel: +44 1952 2900 11
Fax: +44 1952 2904 59

Fasteners Division
St Cosme Operations
9 rue de Cressonnieres
72110 Saint Cosme en Varais
France
Tel: +33 0 2.43.31.41.00
Fax: +33 0 2.43.31.41.41

Fasteners Division
Kelkheim Operations
Industriestr. 6
65779 Kelkheim
Germany
Tel: +49 [0] 6195 8050
Fax: +49 [0] 6195 2001

AFSRHuck.net
Youtube.com/AFSIndustrial

**Alcoa
Fastening
Systems & Rings**



The information contained in this publication is only for general guidance, and is not intended to create any warranty, express, implied, or statutory; all warranties are contained only in AFSR's written quotations, acknowledgments, and/or purchase orders. It is recommended that the user secure specific, up-to-date data and information regarding each application and/or use of such products.

